

Heritage 'Putty Line' Windows

Aluminium Steel Replacement With A 45° 'Putty Line'



Duration Windows

Units 4-5,
Charfleets Road,
Canvey Island,
Essex. SS8 0PQ

t: 01268 681612 (15 lines)
f: 01268 510058
e: sales@duration.co.uk
w: www.duration.co.uk



DURATION WINDOWS

Aluminium Manufacturers Of Distinction Since 1985

Aluminium Steel Replacement Windows

These 45° 'Putty Line' aluminium windows are the perfect solution for the replacement of existing putty glazed steel windows. Available in a wide range of styles and designs including top, side and bottom hung. Designed to replicate the appearance and slim sight lines of old putty glazed steel windows whilst offering superior security, weather and thermal performances.

Now you can easily and affordably replace your old, single glazed steel windows with non-rusting and secure windows with the latest gas filled double glazed sealed units. What's more you can do so without compromising the classic look of your period property.

The slim profiles and 45° angled putty line emulates the look of putty glazed steel windows. Whether combined with new or original oak frames, or fitted directly to brick, these windows can be made to look like the windows they replace.

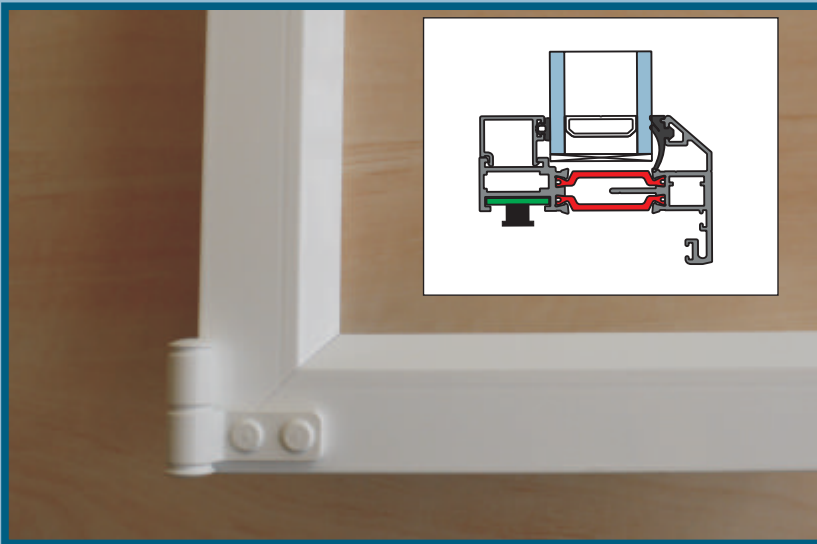

Features

- Standard colours - White, Black, Brown and Silver.
- Available in any single or dual RAL custom colours or textured paint finish.
- A range of traditional furniture options.
- Modern multi-point and multi-side locking.
- Slim-line 58mm polyamide thermally broken, non-rusting aluminium profile.
- Can be supplied unglazed or glazed for 28mm glazing.
- Internally glazed sashes for added security, and ease of installation.*
- Site-lines of just: Outer frame: 43mm; Outer frame - Sash: 67mm;
- Exceeds Building Regulations.
- Suitable for new build as well as replacement or refurbishment projects.
- Suitable for use in listed buildings and conservation areas.

*fixed lites are externally glazed.

Contact Us For Further Information



(827)

Available in: White, Black, Gold, Chrome, Black Chrome, Silver or Stainless Steel

Modern Chelton® Slimline Handle

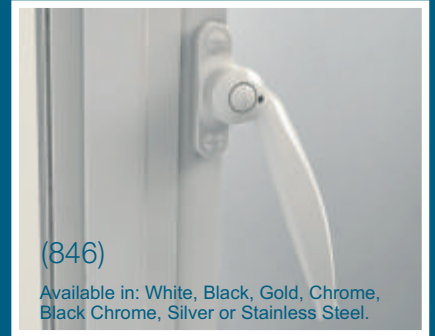

(846)

Available in: White, Black, Gold, Chrome, Black Chrome, Silver or Stainless Steel.

Art Deco Style Chelton® Steel Handle

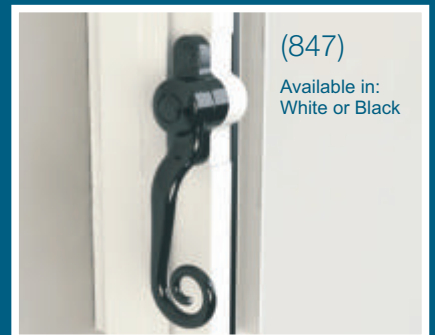

(847)

Available in:
White or Black

Period Chelton® Monkey Tail Handle



Easy Clean Friction Hinges



Commercial Installation

Exceeding The Standards For Modern Living

This window exceeds the building regulations making it suitable for new build as well as replacement and refurbishment projects and is still a fraction of the cost of steel windows. Featuring:

- Traditional furniture options. Choice of three handles from our Chelton® handle range. Incorporating modern multi-point + multi-side Chelton Secure™ locking.
- Polyamide thermally broken, non-rusting aluminium profile.
- 28mm double glazed latest gas filled sealed units.
- Internally glazed sashes for added security, and ease of installation.*
- Can take trickle vents in head extension or deep outerframe.
- U values as low as 1.3w/m² K.
- Window energy rating 'B' as standard and can be upgraded to and 'A' rated window.
- Exceeds current requirements for Doc L and proposed requirements coming into force in October 2010.

Applications

- New build as well as replacement and refurbishment projects.
- Suitable for commercial or domestic applications.
- For listed buildings, conservation areas and period properties

Sizing

Minimum Height	Maximum Height
350mm	1500mm

Minimum Width	Maximum Width
350mm	1250mm

Maximum Sash Weight
50Kg**

Note:

If the sizes you require are less than the minimum or exceed our maximum recommended sizes contact our technical department.

Variations:

The sizes detailed above are for guidance only. Sash sizes and operation will depend on hardware used, while sash heights & widths are dependant on style and design.**

Contact Us For Further Information

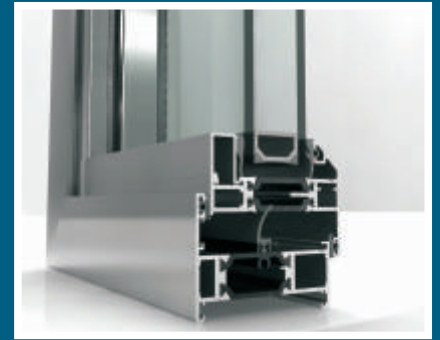

3D Cross Section

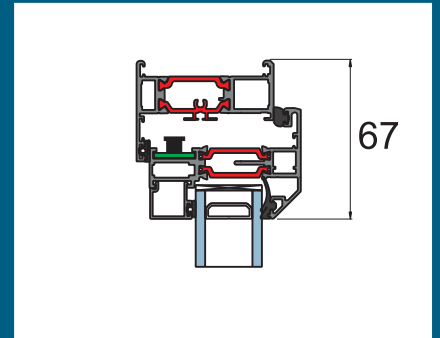

Chelton Vent / Head Detail

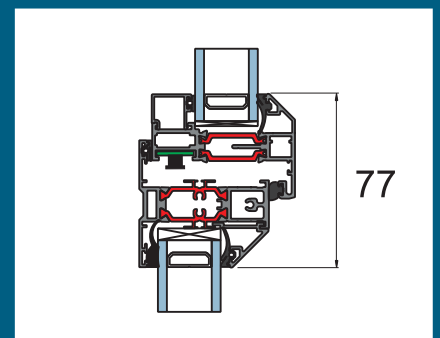



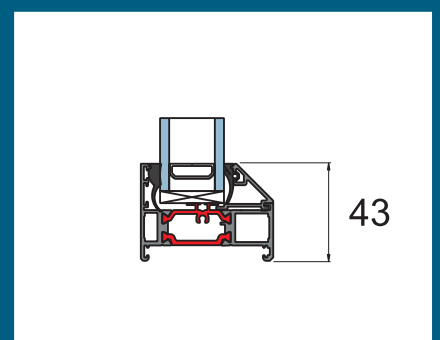



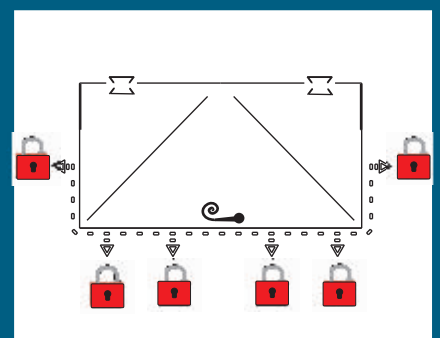



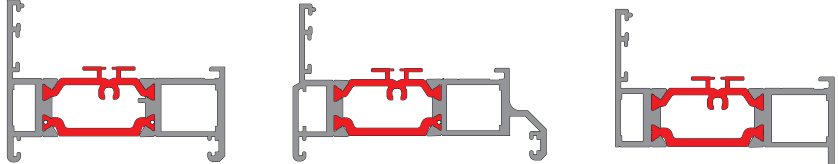
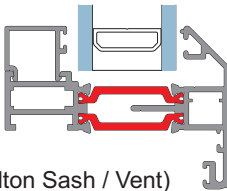

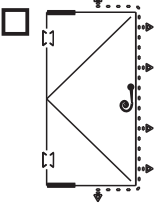
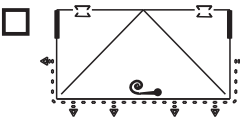
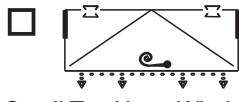

Chelton Vent / Transom Detail

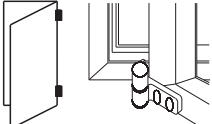
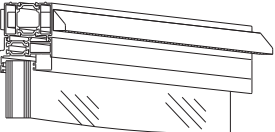

Bottom Detail Fixed Lite



Chelton Secure™ Locking

<p>Outer frame Options</p>	 <p> <input type="checkbox"/> AW604 (Slim Equal-leg) 58mm <input type="checkbox"/> AW600 (Slim D/F) 70mm <input type="checkbox"/> AW603 (Odd Leg) 58mm </p>		
<p>Sash / Vent Details</p>	<p>Chelton Handles fitted directly into the bead.</p>  <p><input checked="" type="checkbox"/> AW675 (Chelton Sash / Vent)</p>		
<p>Chelton® Handle Range</p>	<p> <input type="checkbox"/>  DUR827 Modern Chelton® Slim-line Handles </p> <p> <input type="checkbox"/>  DUR846 Art Deco Chelton® Steel Handles </p> <p> <input type="checkbox"/>  DUR847 Period Chelton® Monkey Tail Handles </p>		
<p>Chelton Secure Locking</p>	<p> <input type="checkbox"/>  Side Hung Window </p> <p> <input type="checkbox"/>  Standard Top Hung Window </p> <p> <input type="checkbox"/>  Small Top Hung Window </p> <p>  Chelton Handle  Locking Point  Sash Jammers </p>		
<p>Hinges & Dummy Butts</p>	<p> <input checked="" type="checkbox"/>  Friction Hinges Are Fitted As Standard </p> <p> <input type="checkbox"/>  Add Mock/ Dummy Butt Hinges to Openers. </p> <p> <input type="checkbox"/> Yes <input type="checkbox"/> No </p>		
<p>Trickle Vents</p>	<p> <input type="checkbox"/> No Trickle Vents To Be Fitted </p> <p> <input type="checkbox"/>  Trickle Vents Fitted To Frame Extension At Top Of Window. </p>		
<p>Other Section Options</p>	<p> <input type="checkbox"/> No Cill </p> <p> <input type="checkbox"/> 96mm  </p> <p> <input type="checkbox"/> 150mm  </p> <p> <input type="checkbox"/> 177mm  </p> <p> <input type="checkbox"/> 190mm  </p> <p> Coupling Section to be Supplied </p> <p> <input type="checkbox"/> None  </p> <p> <input type="checkbox"/> Yes AW702 (15 x 70) </p> <p> <input type="checkbox"/> Yes AW703 (15 x 58) </p> <p> Frame Extension Fixed onto Outerframe </p> <p> <input type="checkbox"/> None  </p> <p> <input type="checkbox"/> Yes, AW725 (25 x 58) </p> <p> <input type="checkbox"/> Yes, AW724 (25 x 70) </p>		

Duration Windows

Units 4-5,
Charfleets Road,
Canvey Island,
Essex. SS8 0PQ

t: 01268 681612 (15 lines)
f: 01268 510058
e: sales@duration.co.uk
w: www.duration.co.uk



DURATION WINDOWS

Aluminium Manufacturers Of Distinction Since 1985